

DrPepperResins

1/48 Tamiya F-16CJ to Blk 40
Barak Conversion Set

What you get in the set

Four 16S210
missile rails

Parabrake
extension with
2 options of
ends

Light housing ECM
bulges

4 "Doughnut panel" ECM
 housings

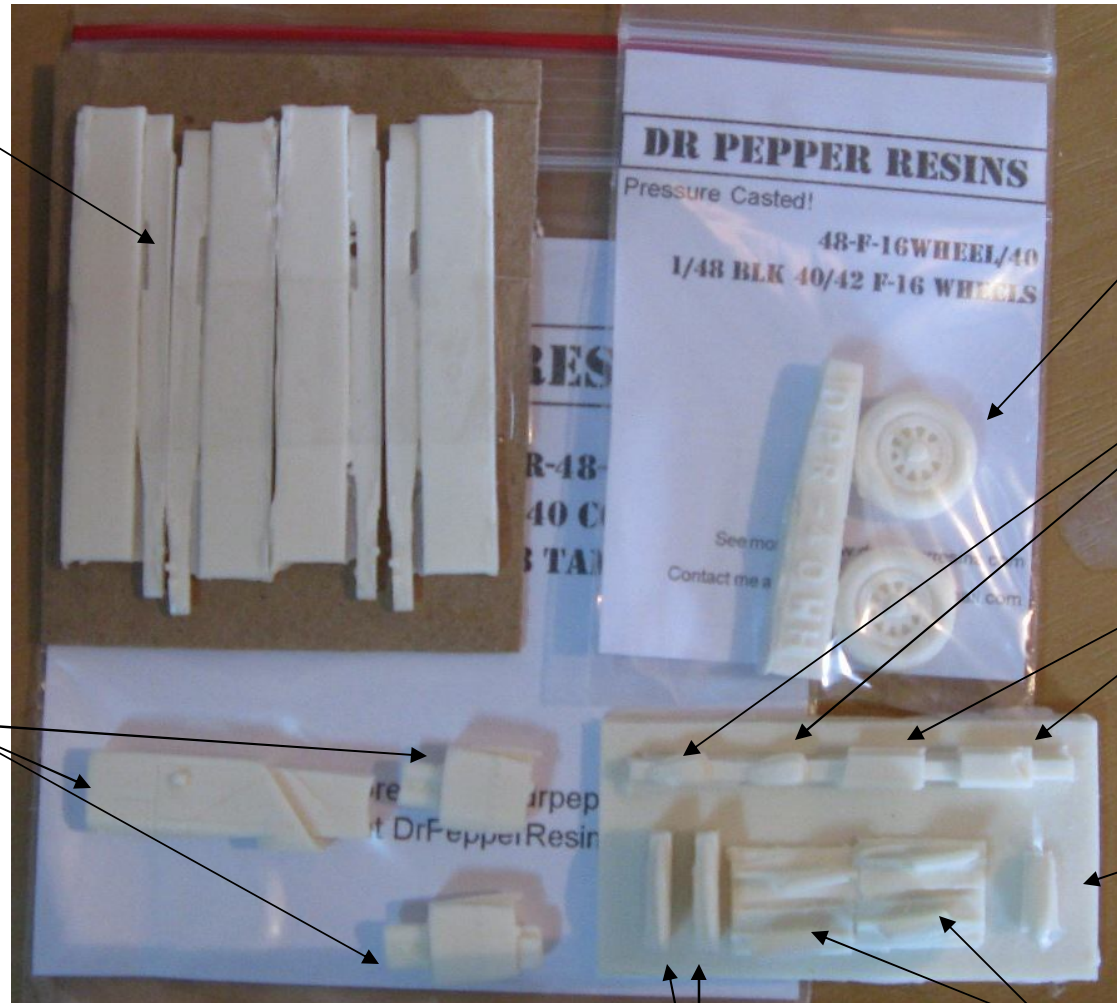

Blk 40
wheels

Nose RWR
bulges

Precooler
intake (2
parts)

Intake
ECM
housing

Installation

- Parabrake Extension

Note: 2 options are provided.
Check your references for which
is to be used for the particular tail

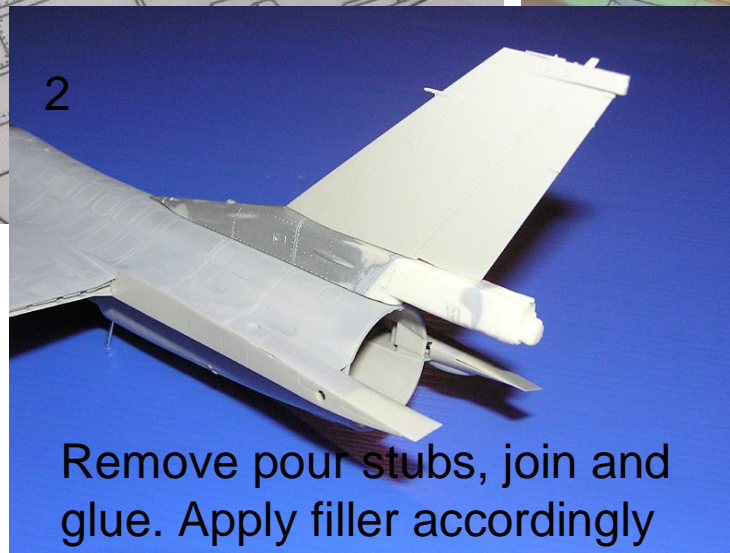
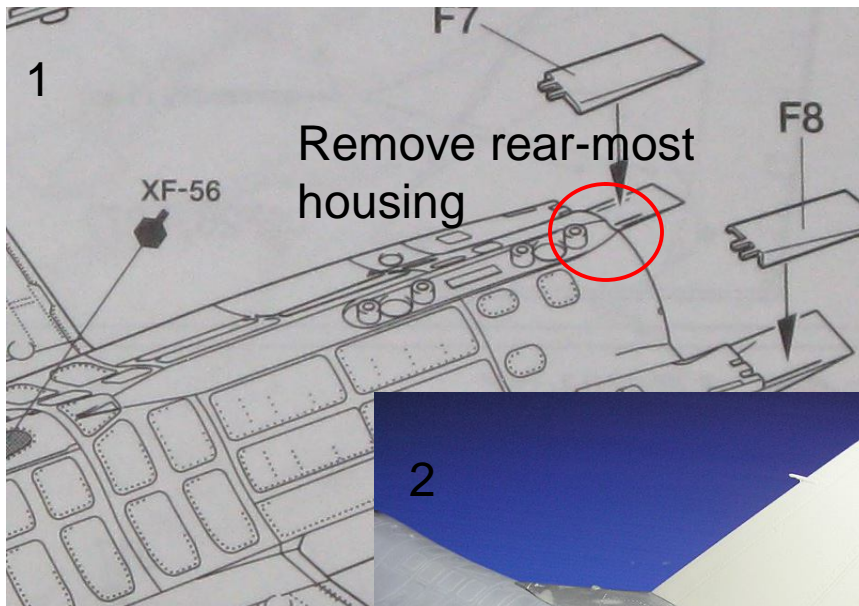

Paint, decal, weather.

Installation

- ECM bumps

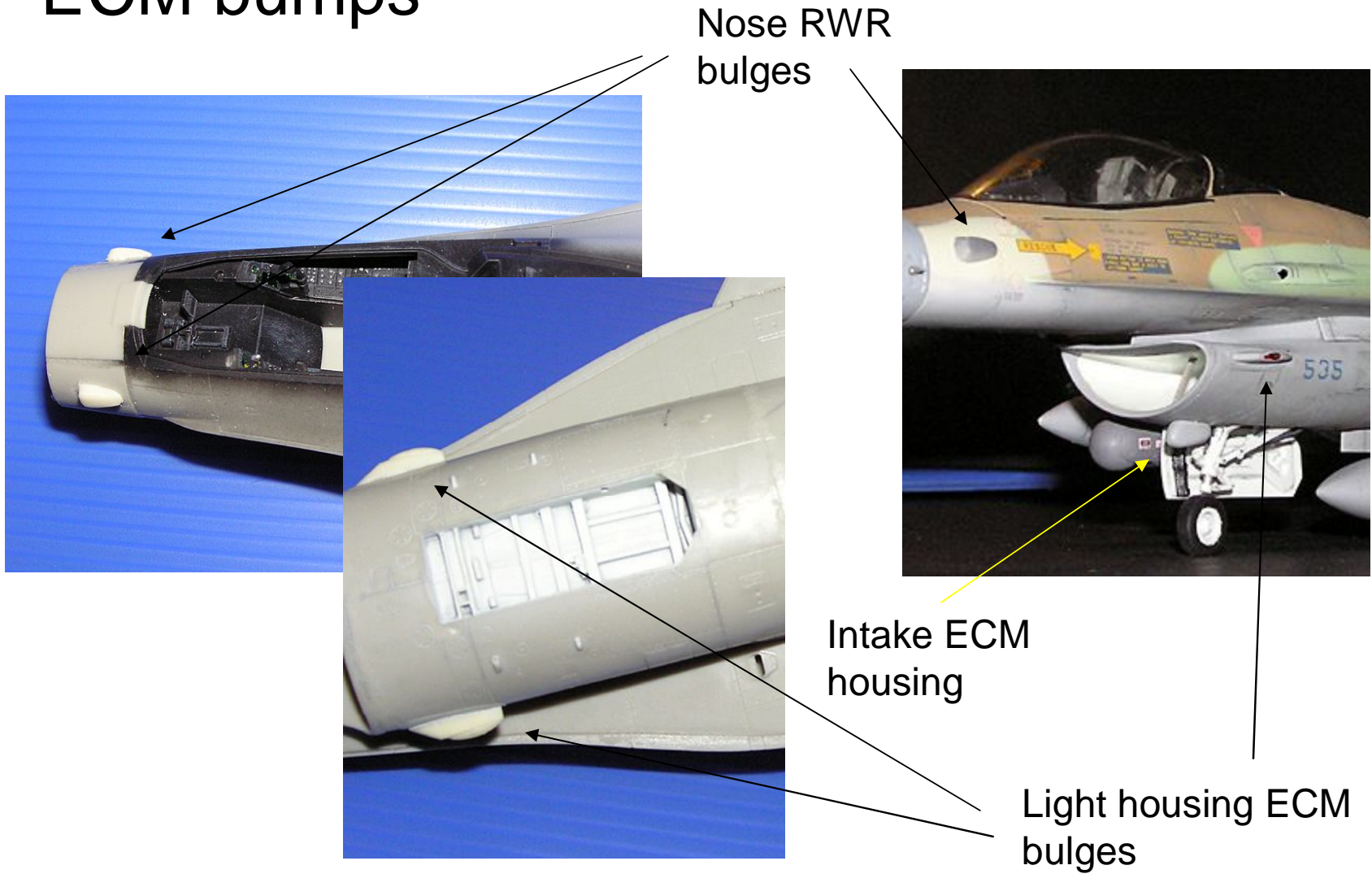

Installation

- **Precooler Intake**
 - Comes in 2 halves

Fwd piece. Install onto fuselage first. Paint same colour as lower fuselage

Rear piece. Install later, after lower fuselage is painted. Bare metal colour, slightly gold/yellowish



Install on panel just above JFS doors.

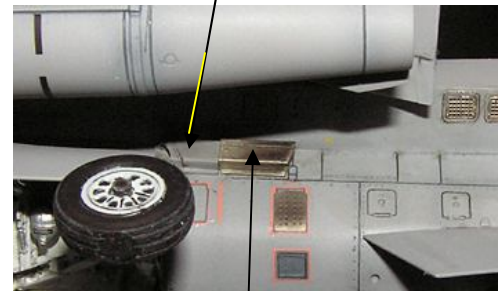

Installation

- 16S210 Missile Rails

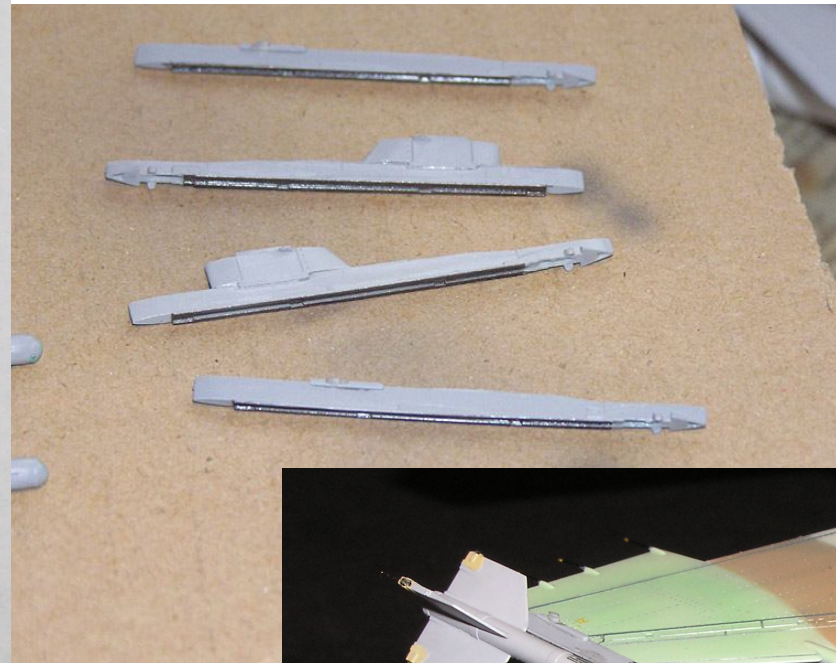
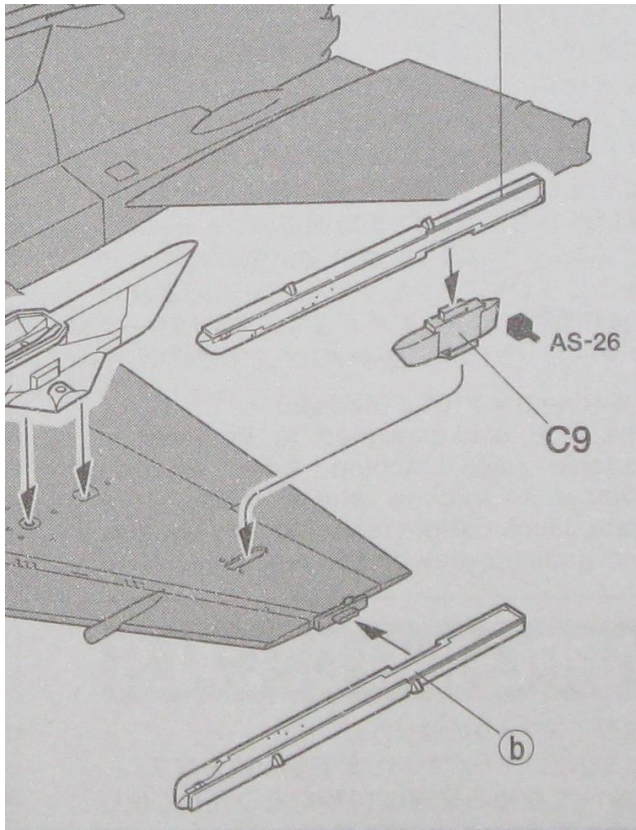

Remove from casting blocks, attach to part C9 and lights, paint, install